

**RIGID EDGE, BUILDING ATTACHED
MEMBRANE STRUCTURES
CASE STUDY: AMADO ROOF STRUCTURE,
TECHNION - ISRAEL**

Michael BURT¹, Ami KORREN²

*1 Professor, Faculty of Architecture and Town planning,
Technion, Haifa, Israel*

*2 PhD of Architecture, Interior & Built Environment Design,
Shenkar College of Engineering and Design*

E-mail: matburt@netvision.net.il korren-a@smile.net.il

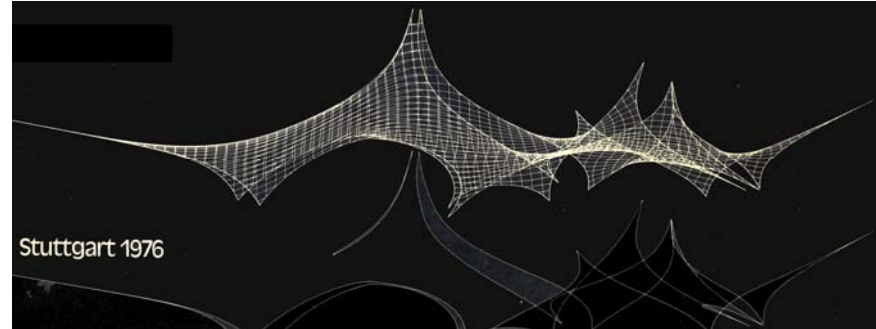

Membrane Space Structures

'Free Form' (Cable perimeter) and
'Rigid Edge' - Alternative Design
Strategies



Rigid Edge Design Approach

Pre-stressed Fabric Membranes
Attached to Rigid Edge Skeletal
Steel Structure

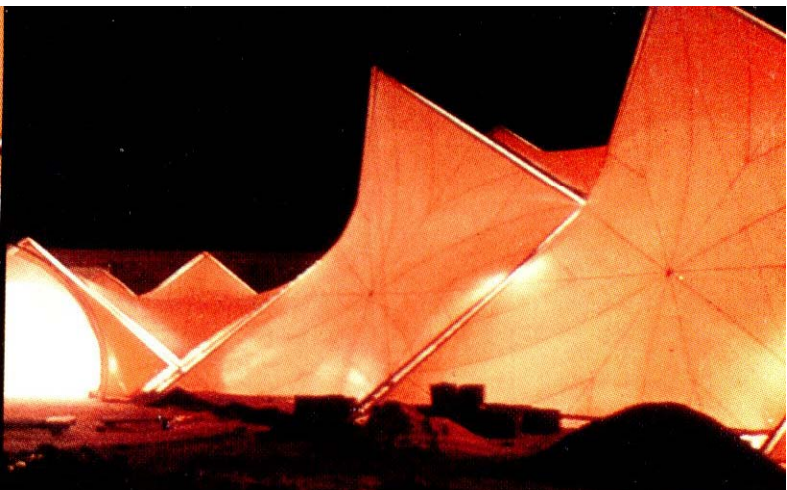



Carmiel commercial center

*Rigid Edge Membrane Space
Structure (3500 sqm)*

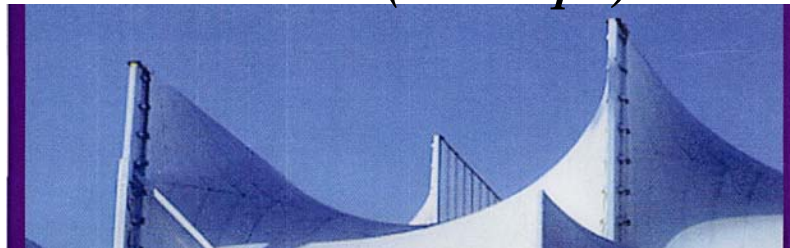



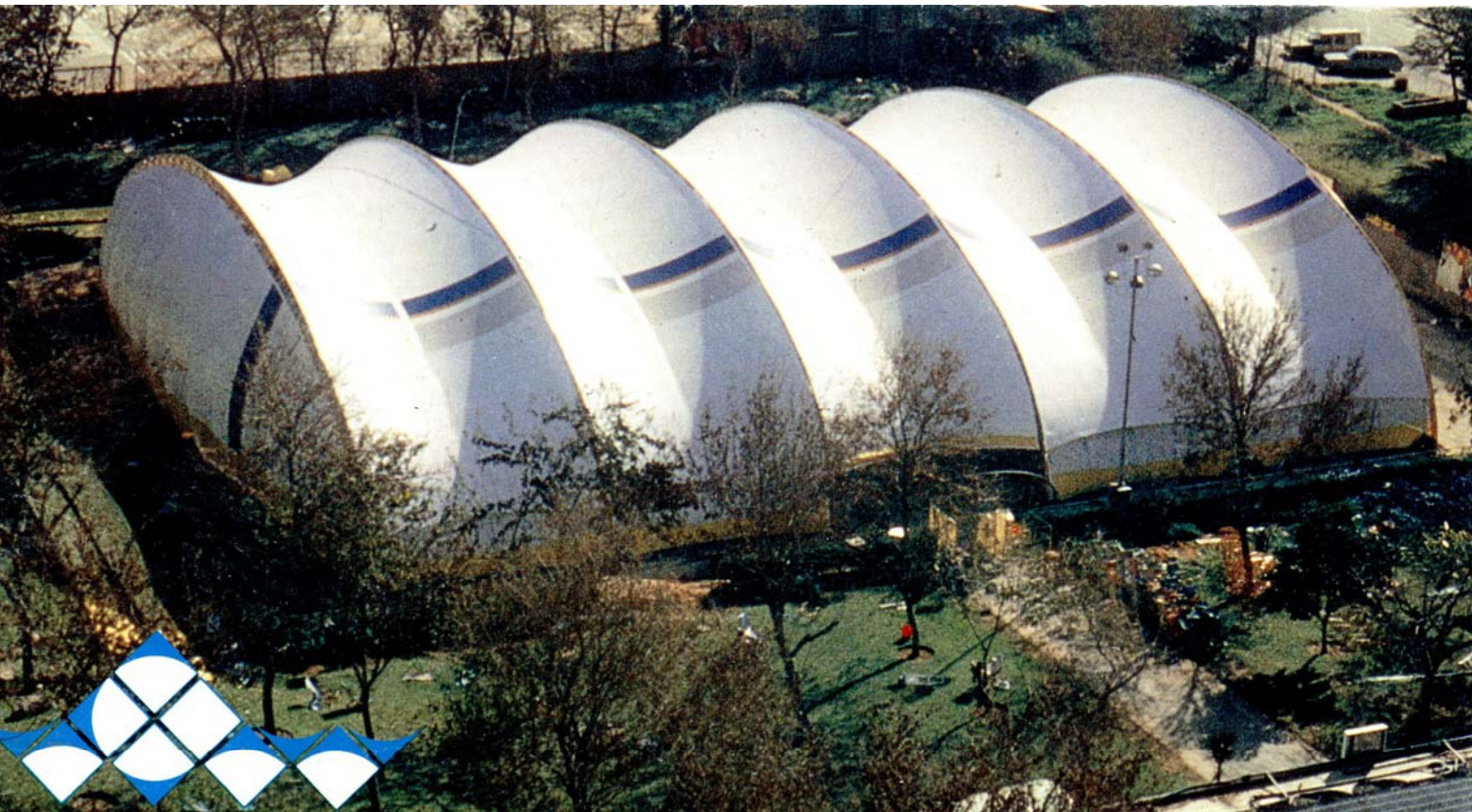



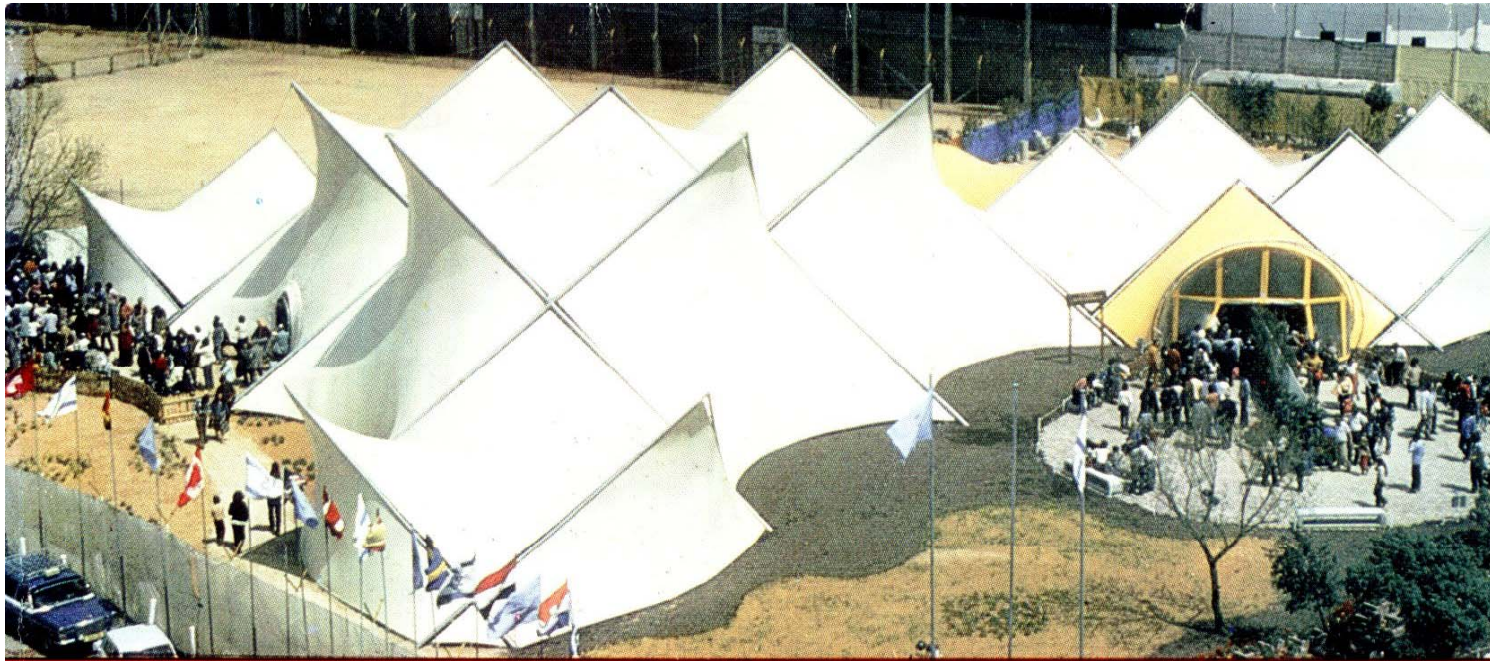

Flower Exhibition
Pavilion - Haifa
1980

Membrane Space
Structure

Close-Pack of
Saddle Polyhedra



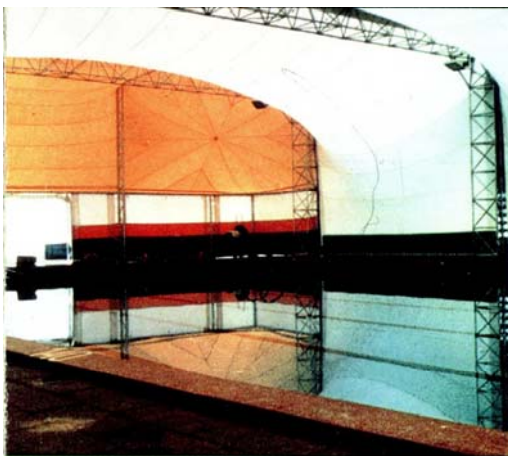
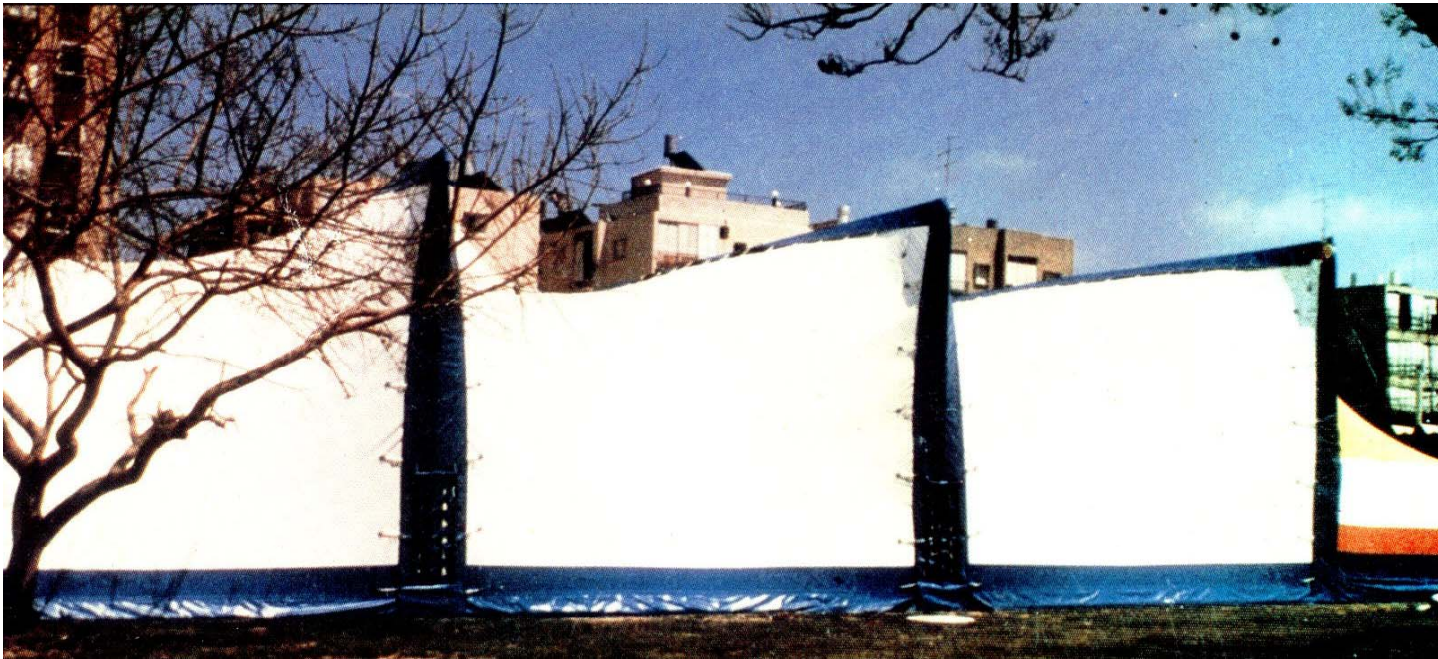

Membrane Space Structure
Holon Swimming Pool Cover,
The Rigid Edge Approach



Morphological Basis of the
Modular “Lego” Approach for
Design of Rigid Edge
Membrane Space Structures

Periodic Hyperbolic (cubic) Surface as a Modular Space Sub-division

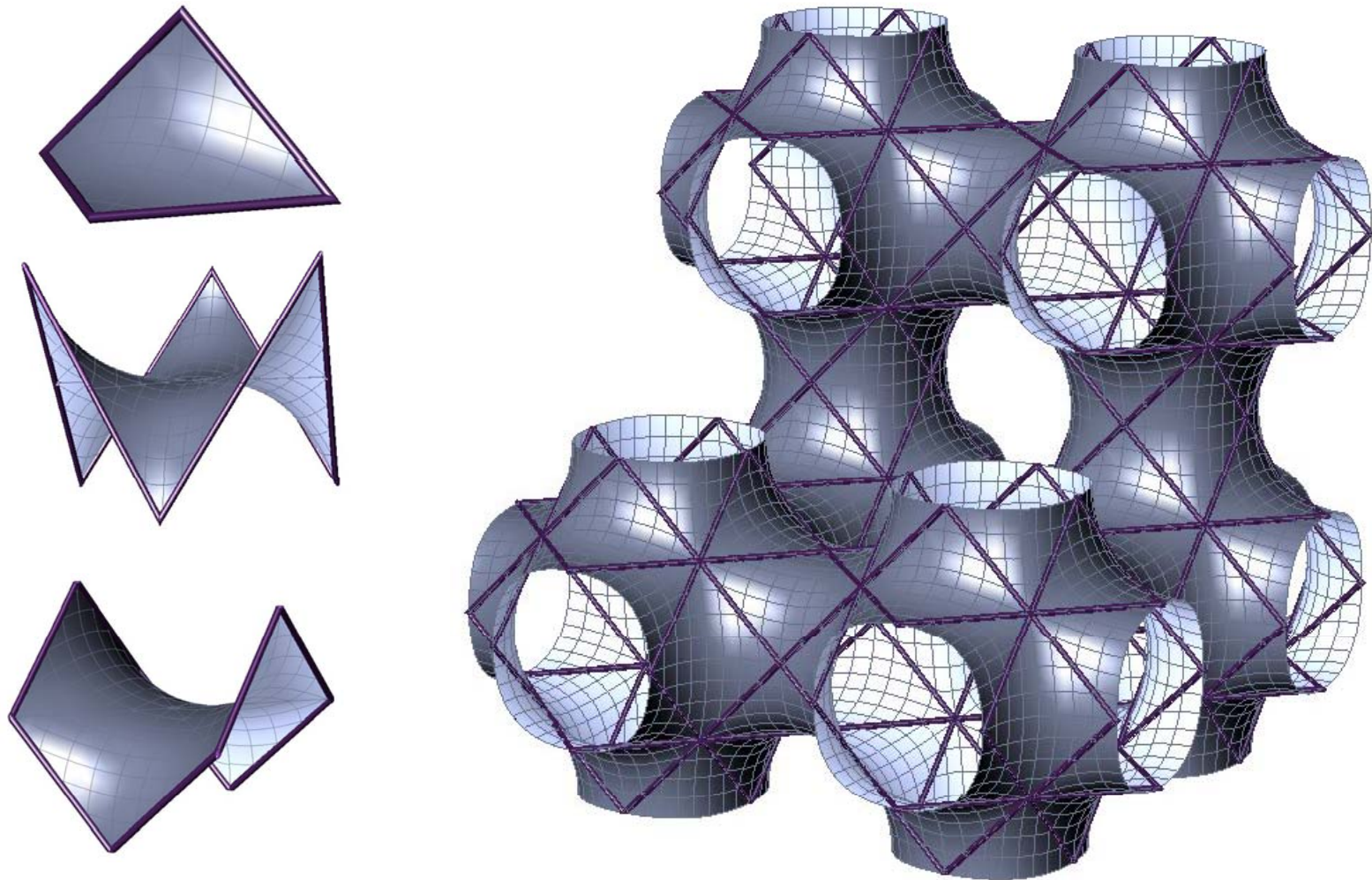

Periodic Hyperbolic (cubic face-centered) Surface as a Modular Space Sub-division

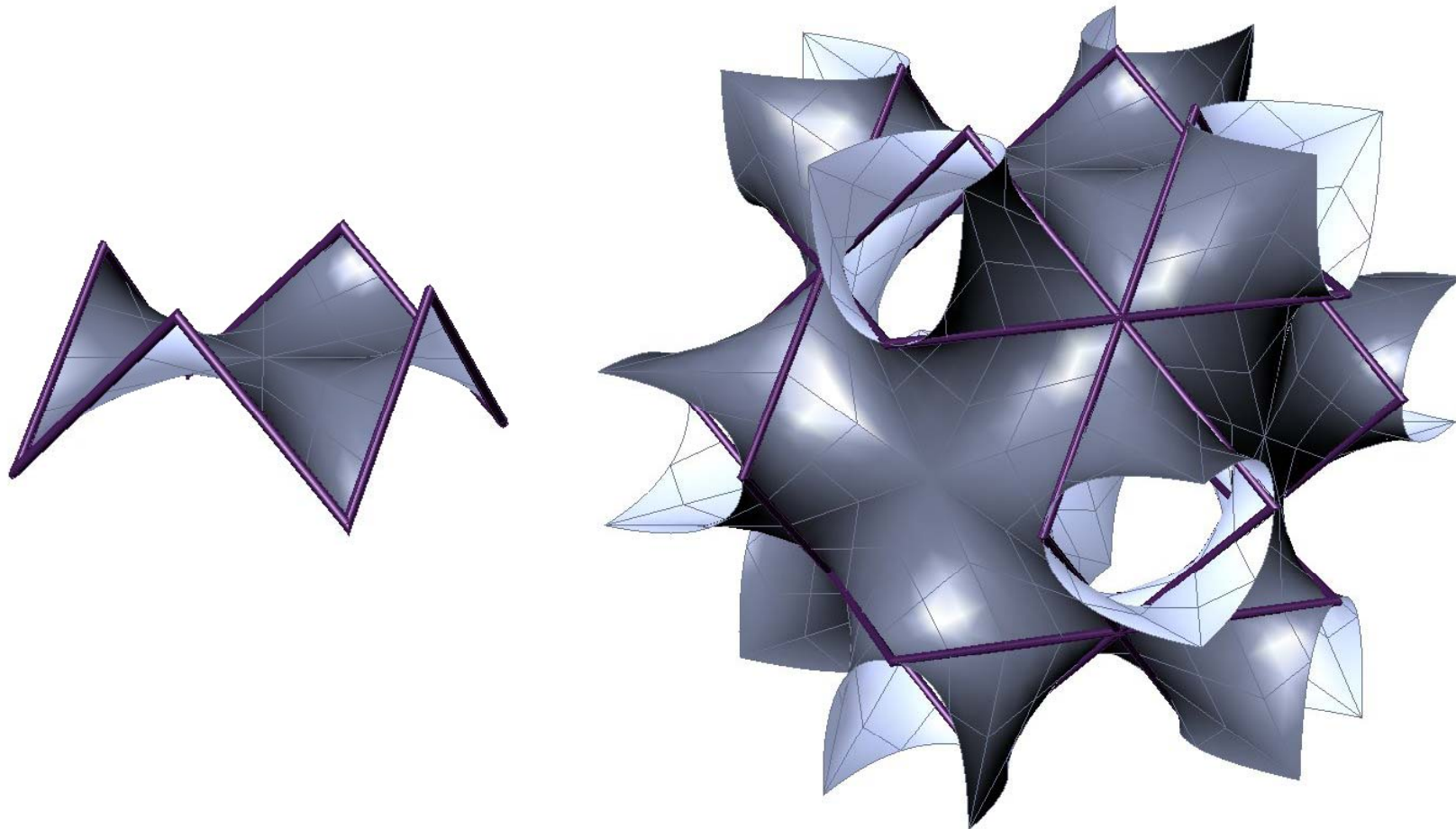

Periodic Hyperbolic (diamond) Surface as a Modular Space Sub-division

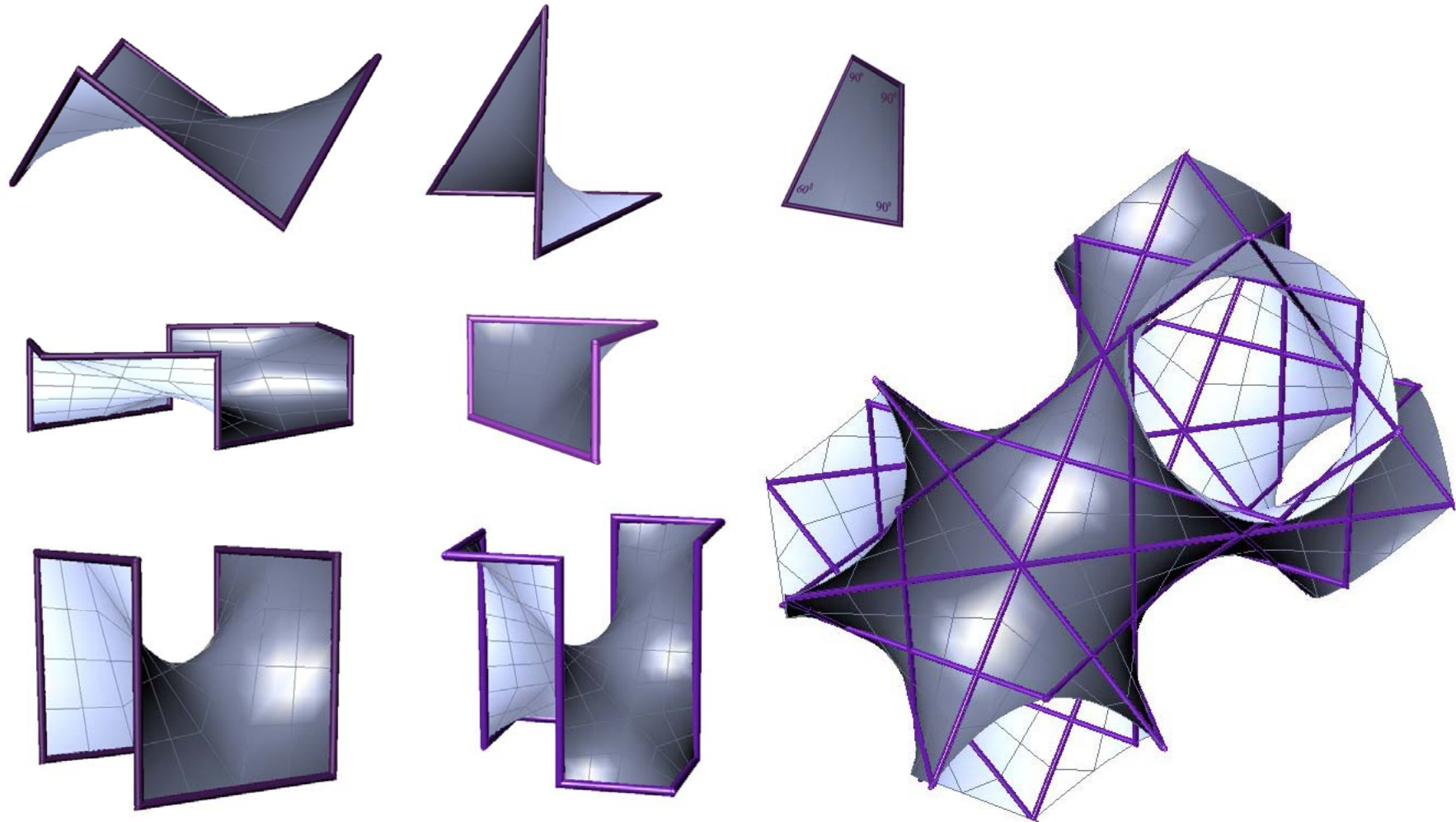

Periodic Hyperbolic (orthogonal) Surface as a Modular Space Sub-division

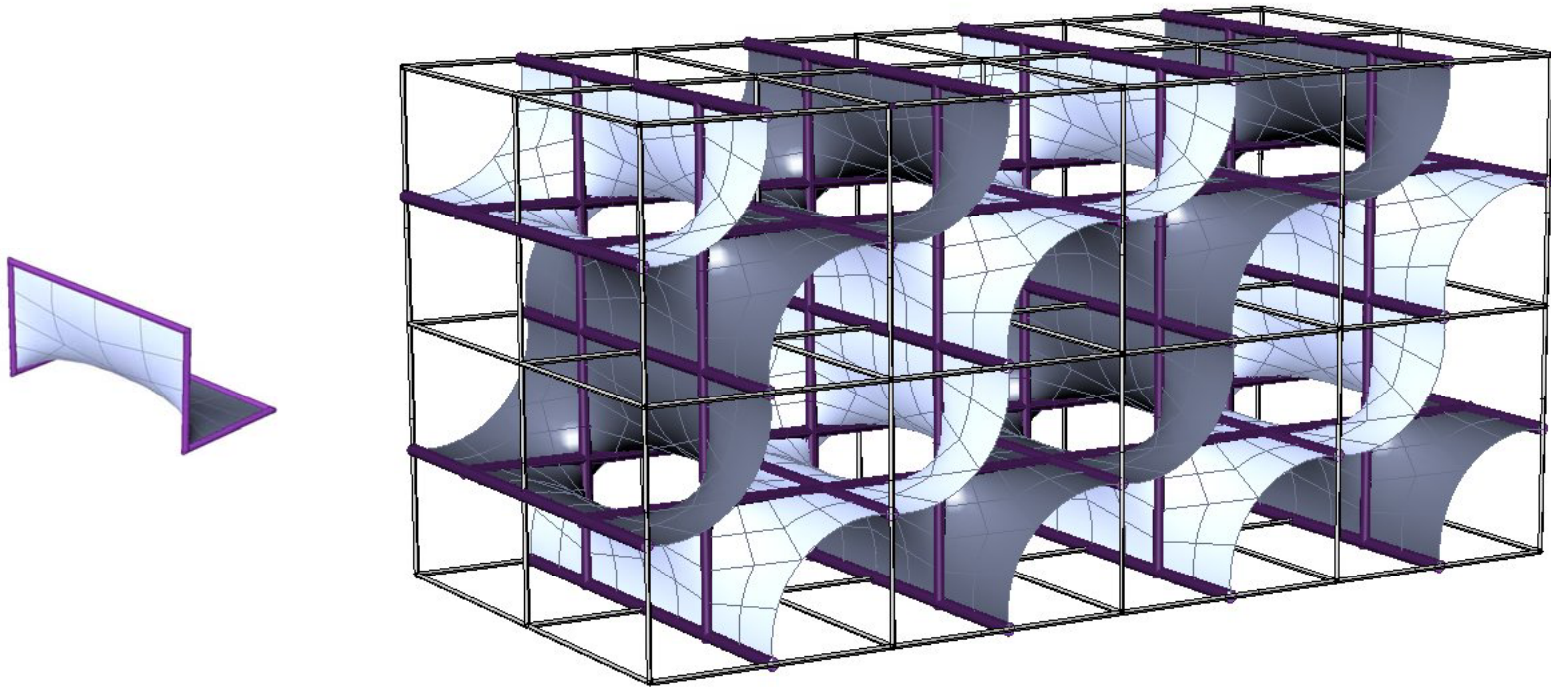

Orthogonal 3-D Straight edge Polygonal “bricks” for modular Membrane Roof System

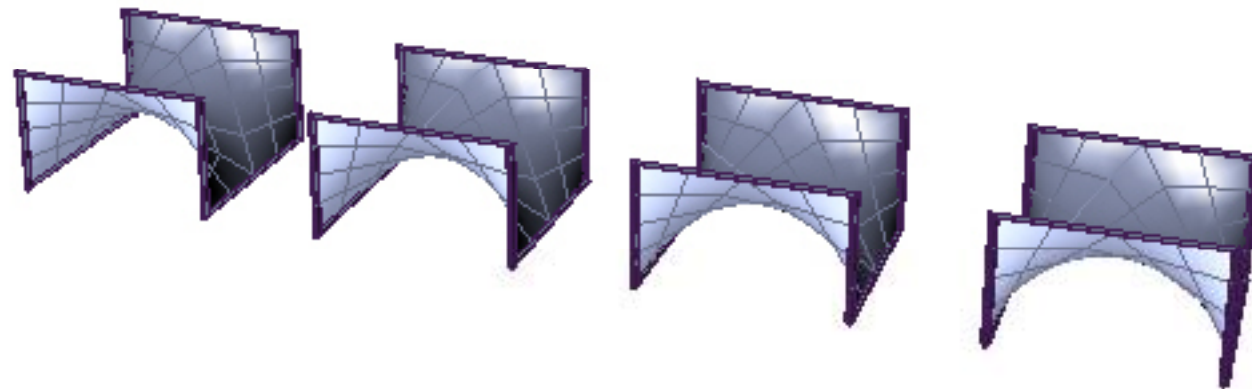

Orthogonal 3-D Straight edge Polygonal “bricks” for modular Membrane Roof System

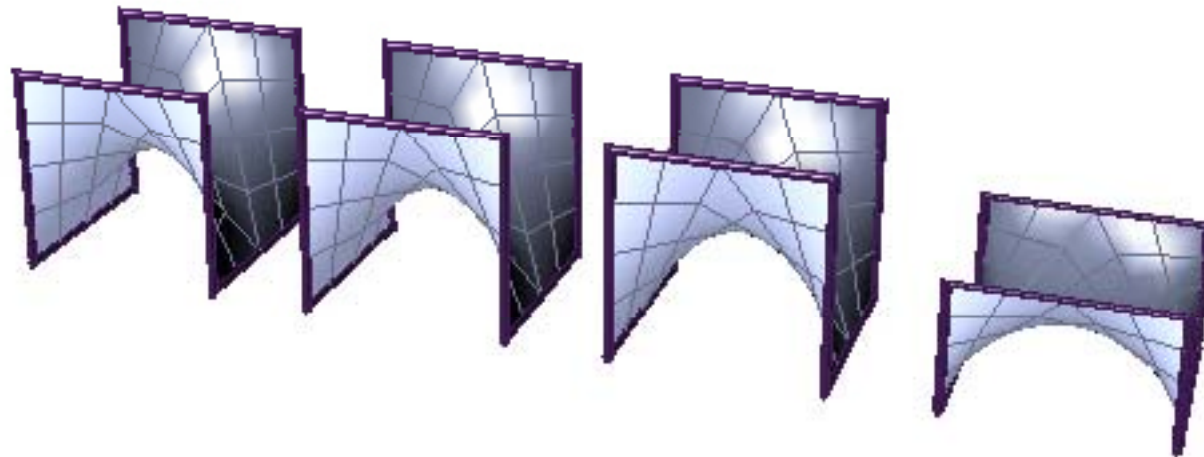

Orthogonal 3-D Straight edge Polygonal “bricks” for modular Membrane Roof System

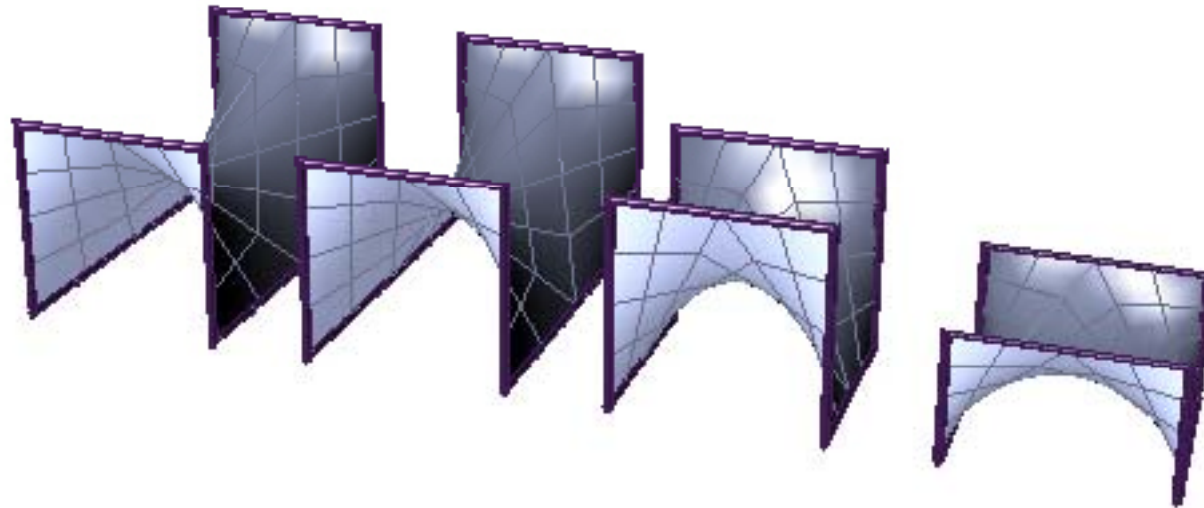

Orthogonal 3-D Straight edge Polygonal “bricks” for modular Membrane Roof System

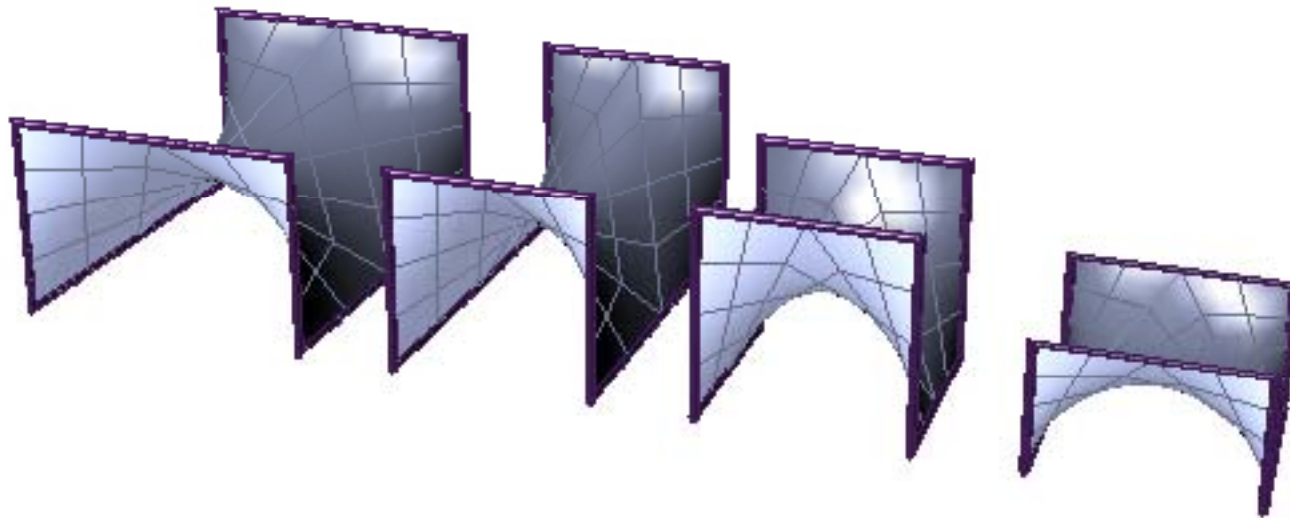

Modular "Rigid Edge" Membrane Roof Structure

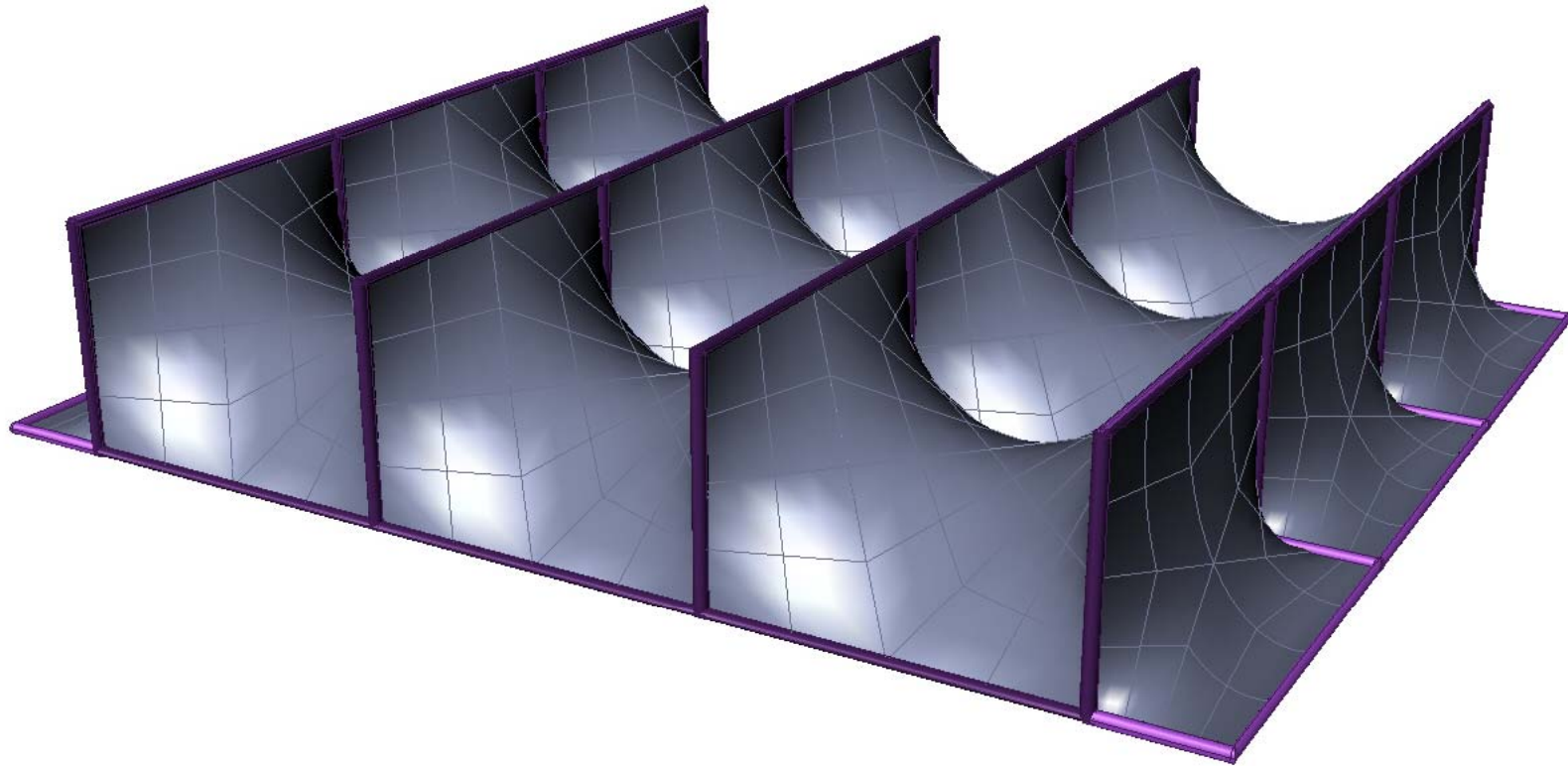

Modular "Rigid Edge" Membrane Roof Structure

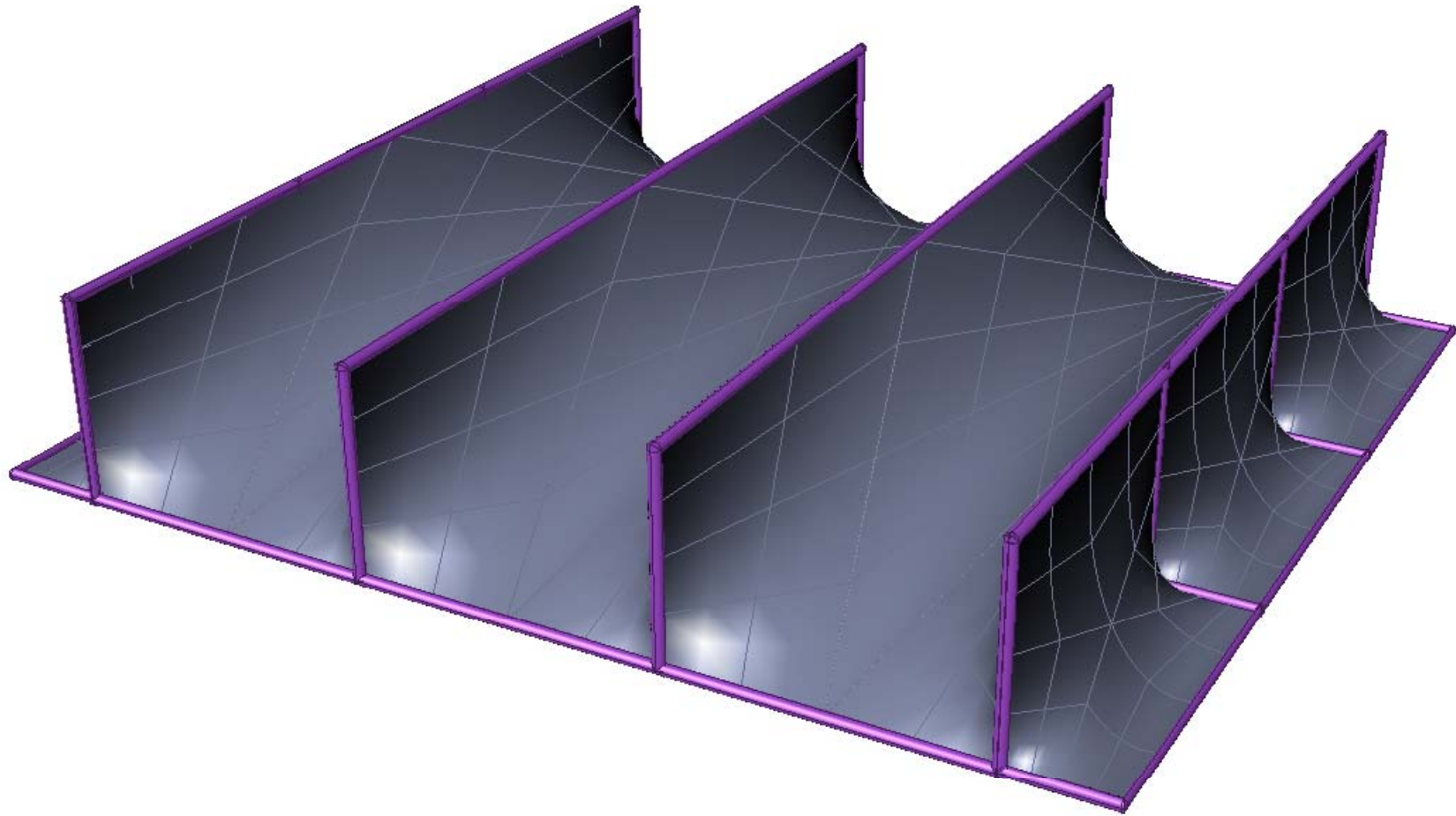

“LEGO LIKE”

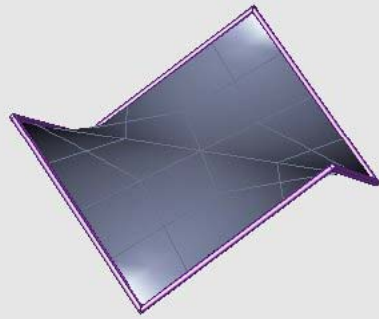

“LEGO LIKE”

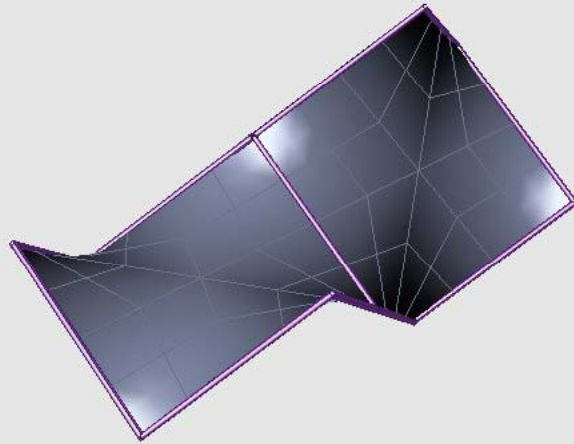

“LEGO LIKE”

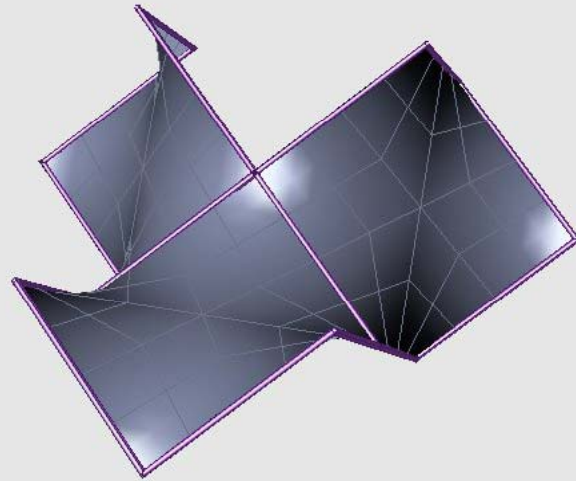

“LEGO LIKE”

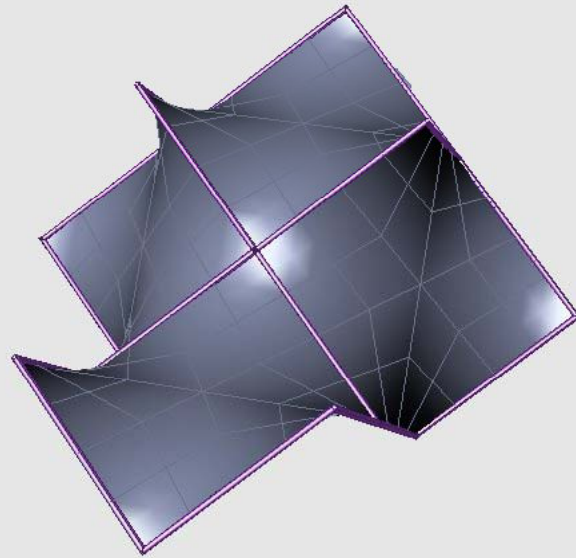

“LEGO LIKE”

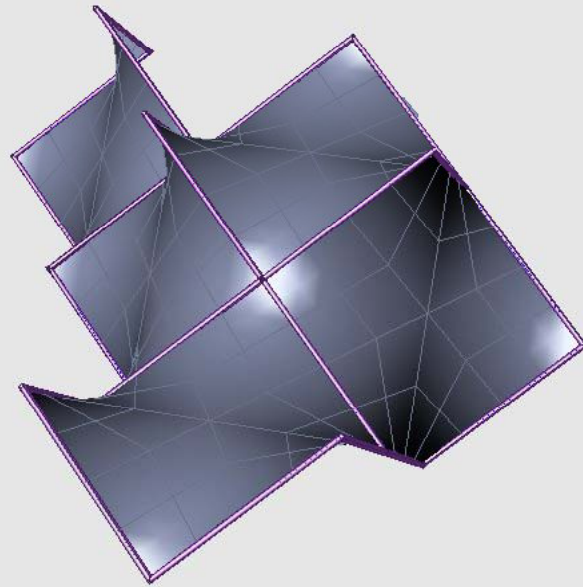

“LEGO LIKE”

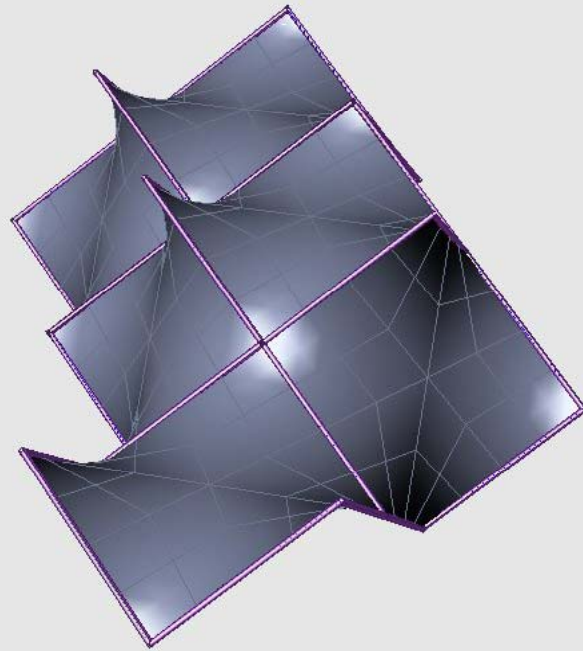

“LEGO LIKE”

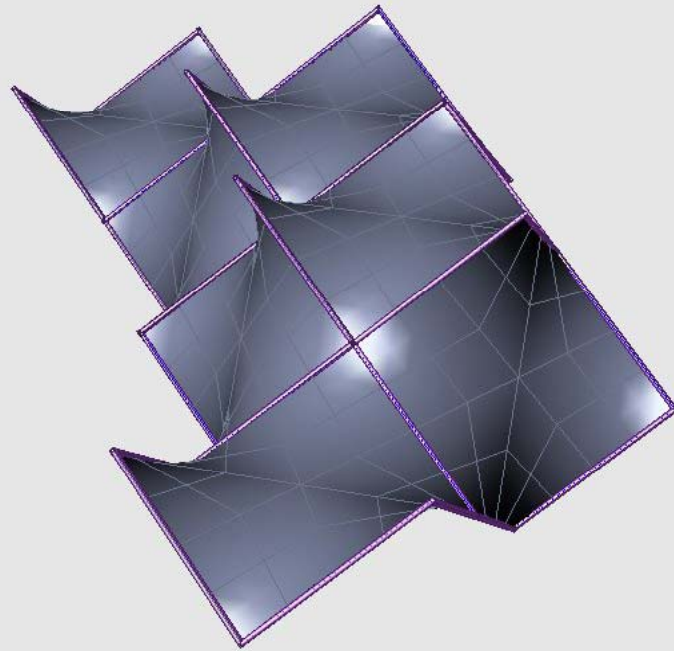

“LEGO LIKE”

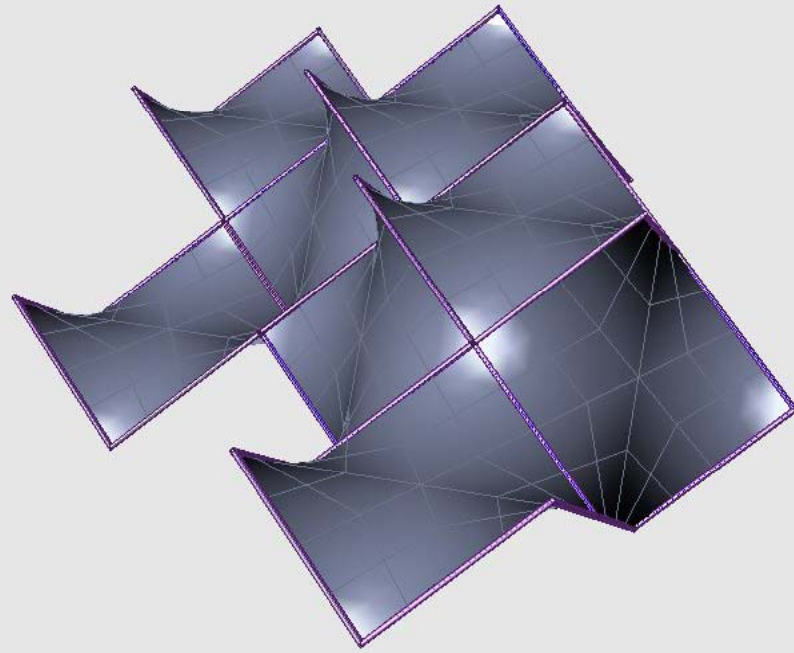

“LEGO LIKE”

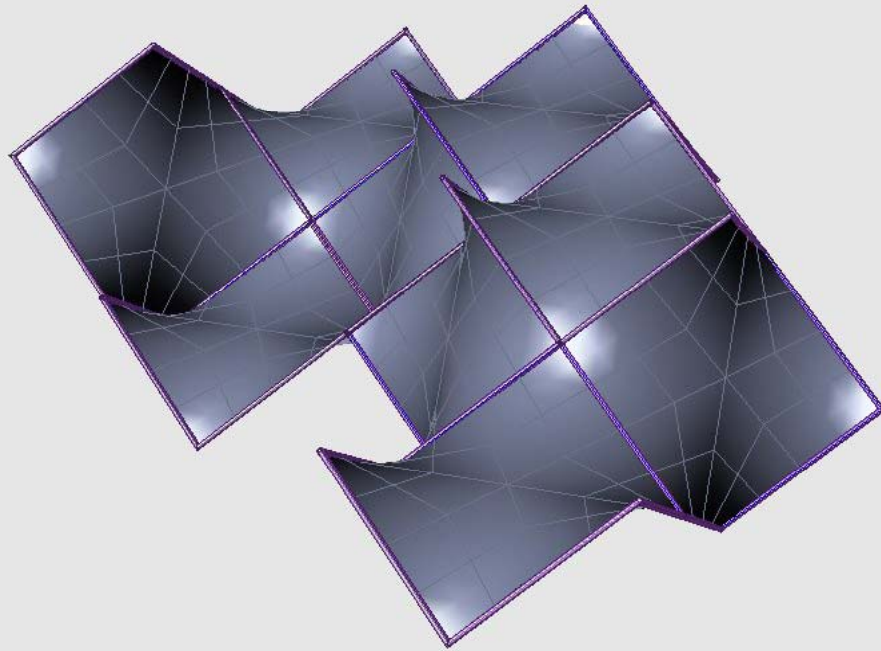

“LEGO LIKE”

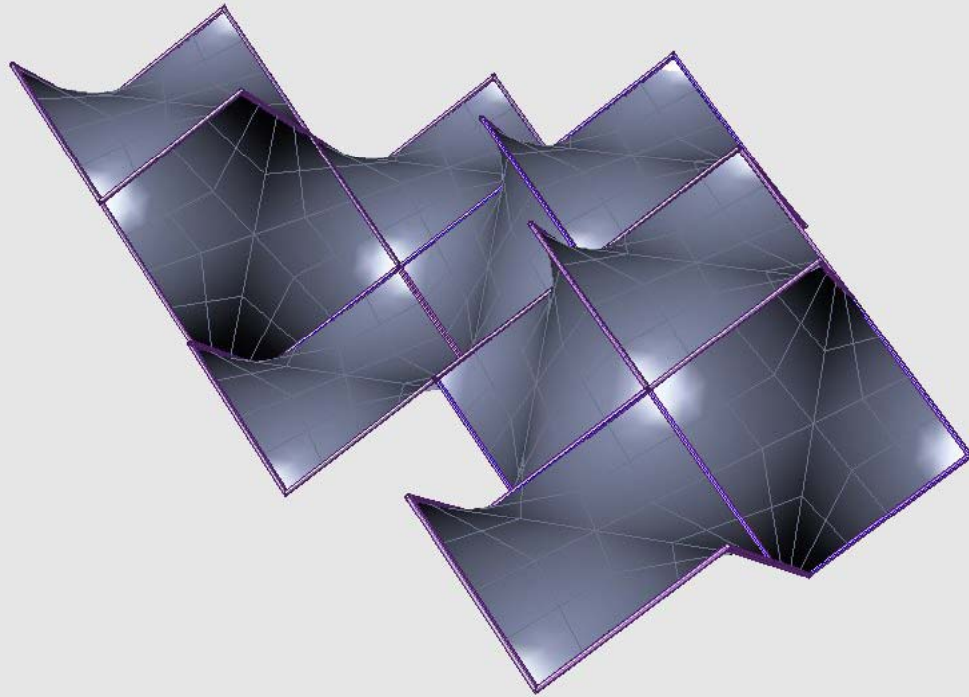

“LEGO LIKE”

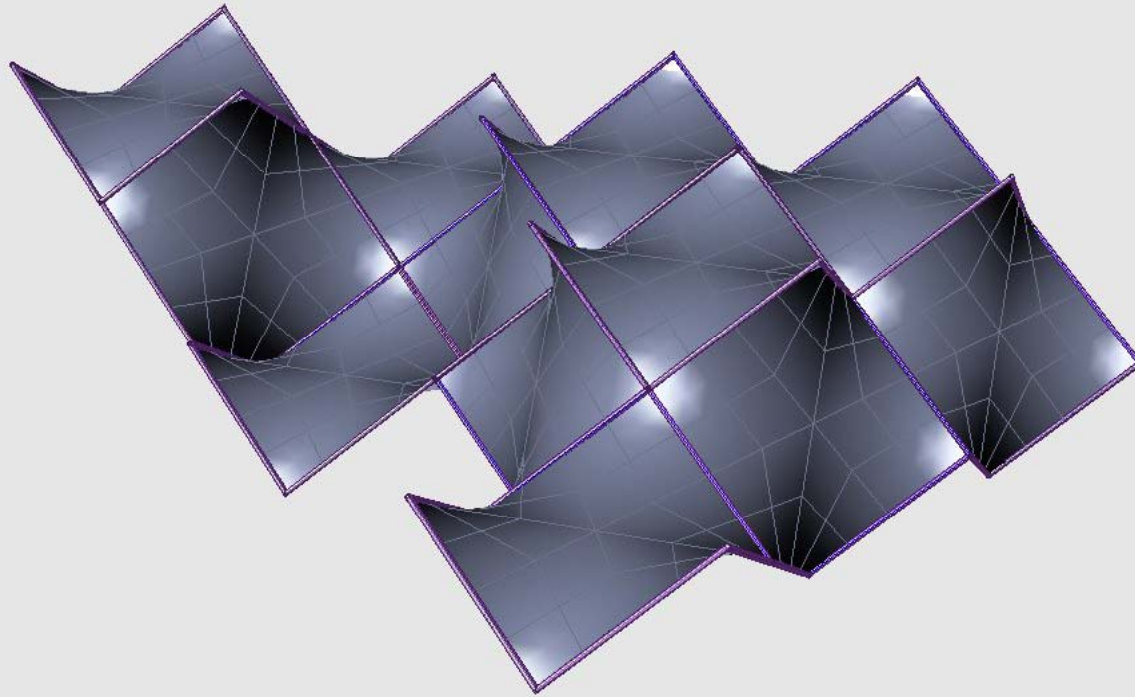

“LEGO LIKE”

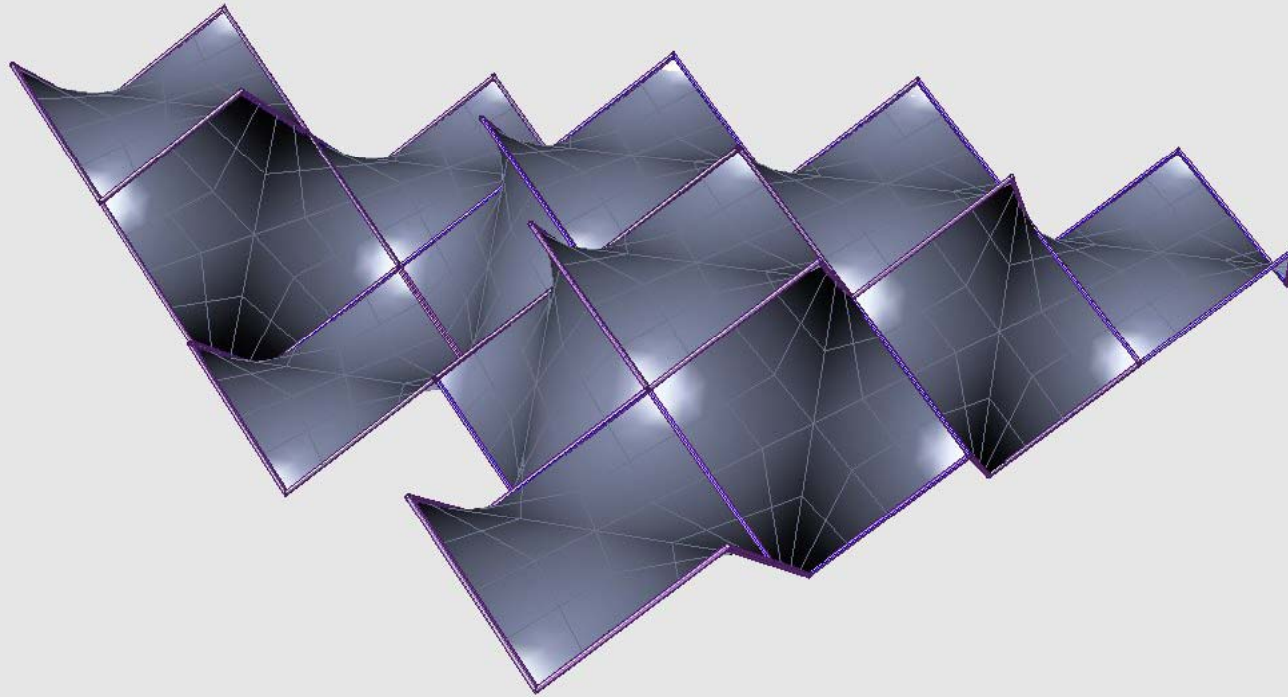

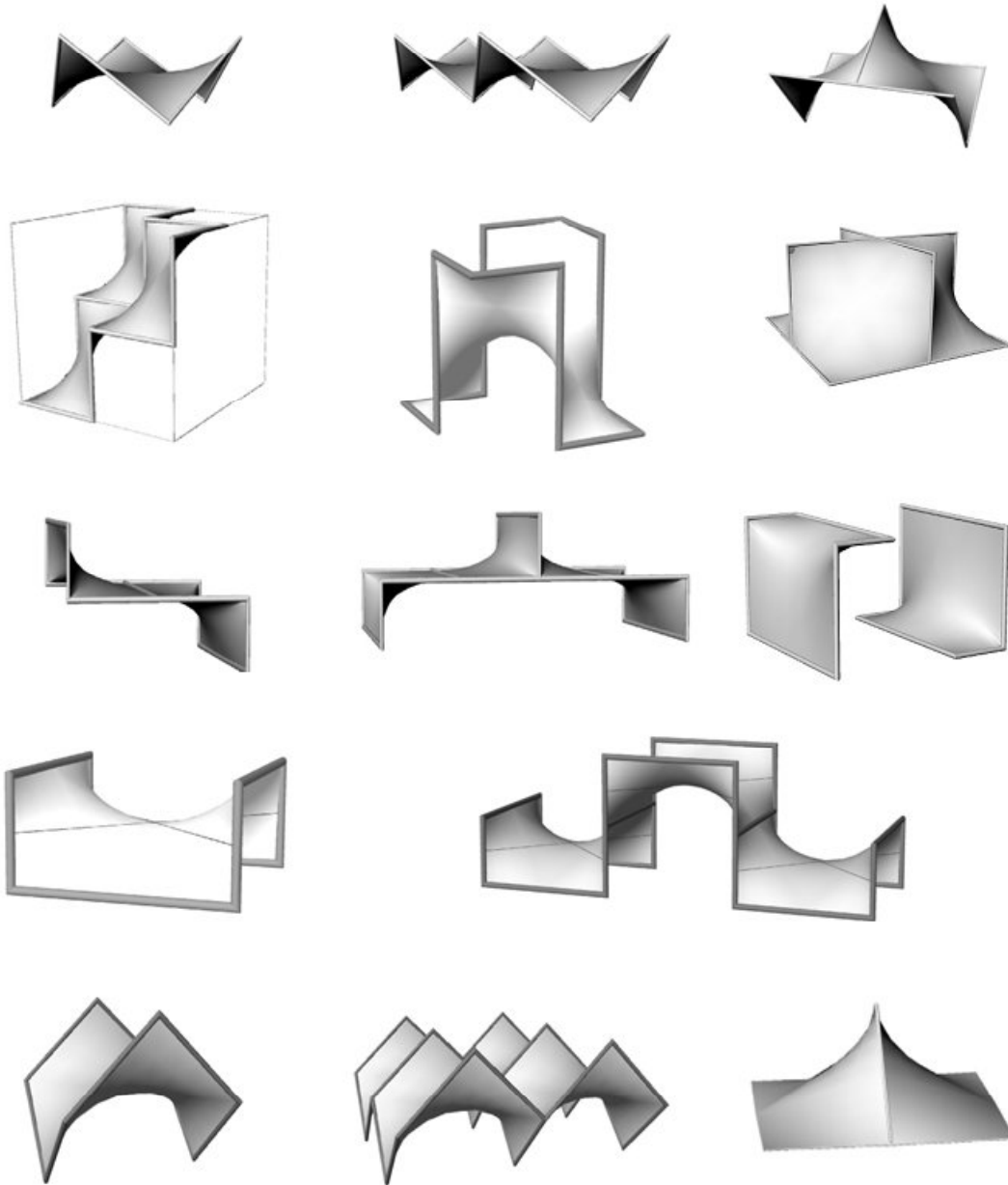

*‘Lego’ like,
orthogonal
membrane
units*

Design

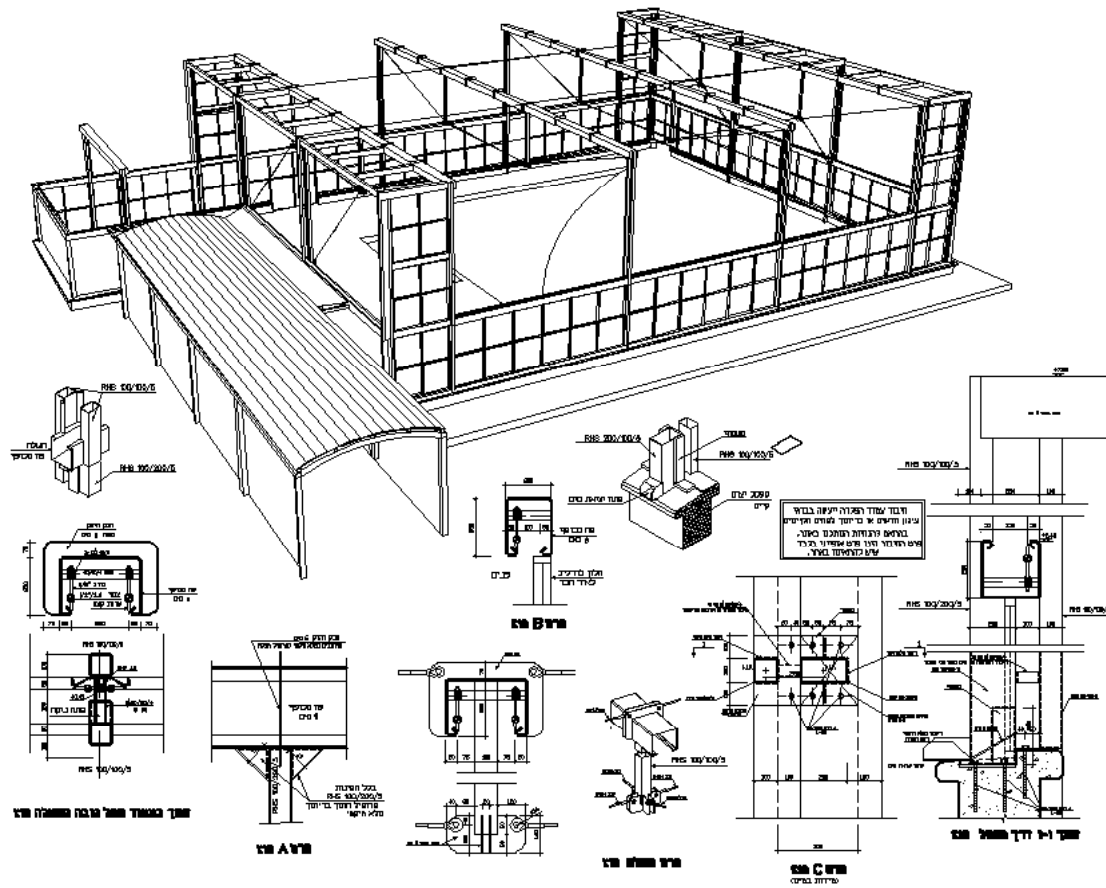

Design

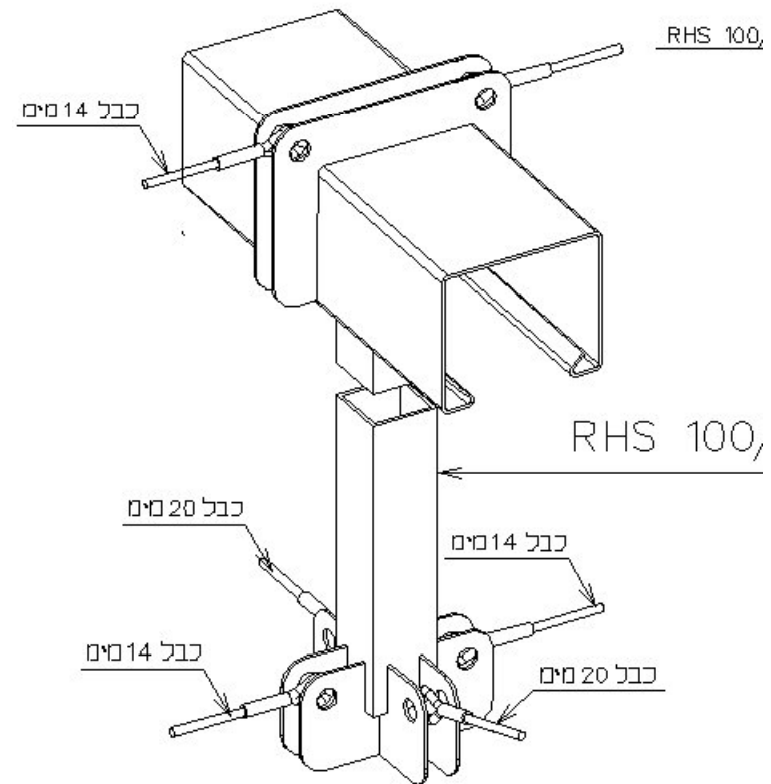
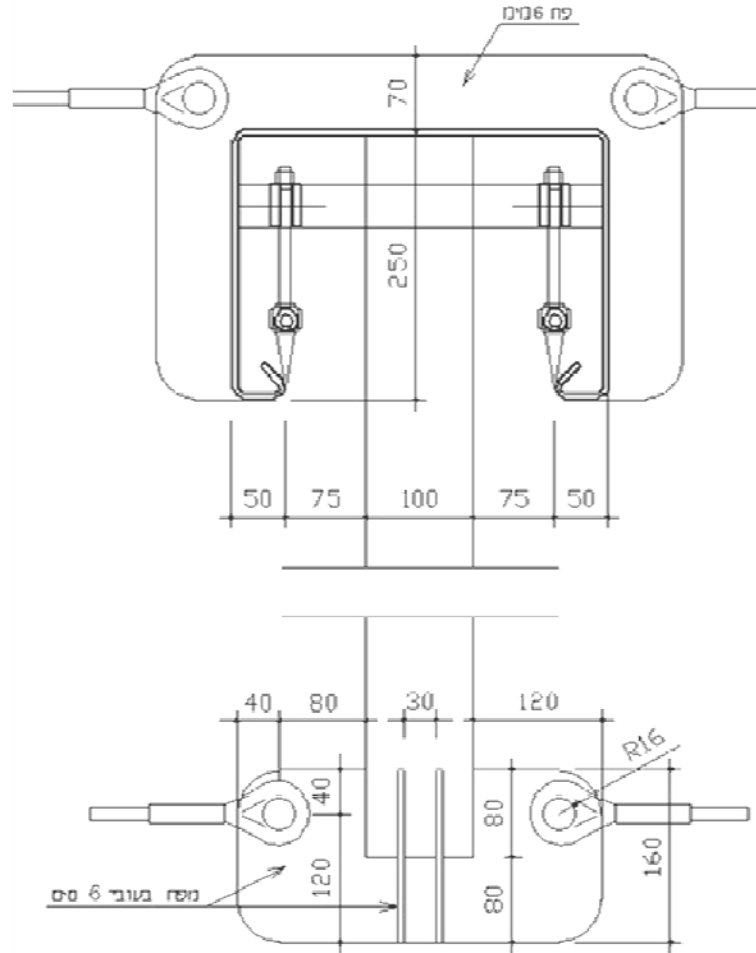

Design

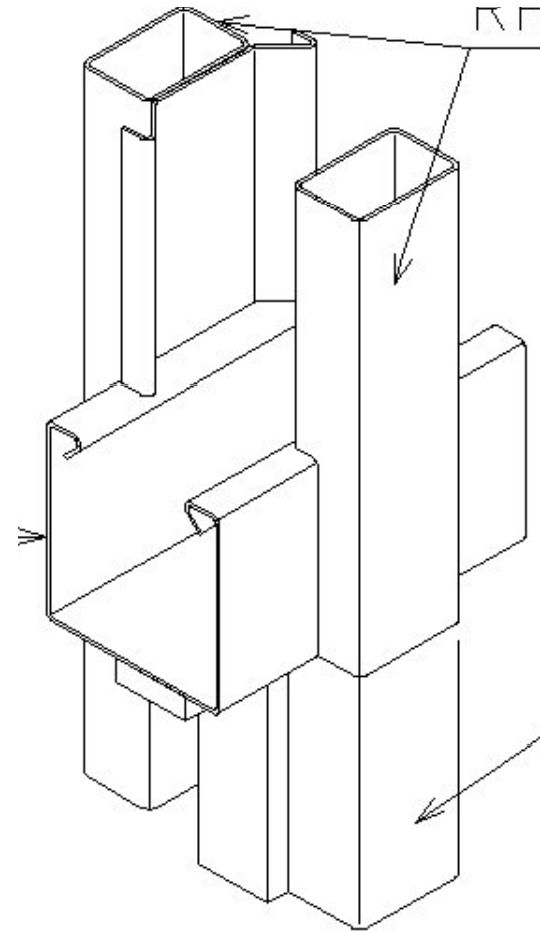
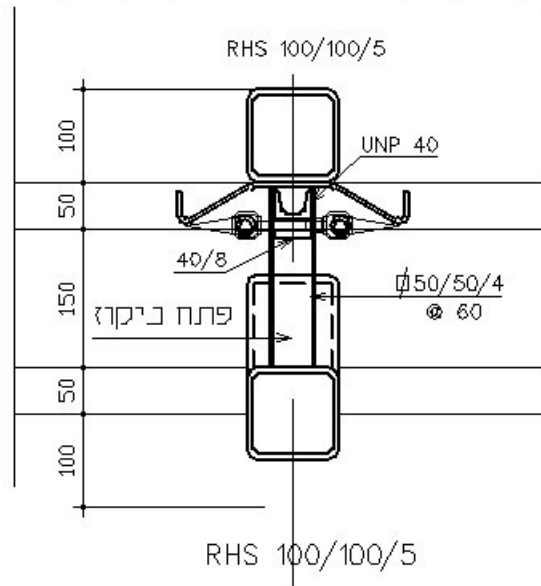
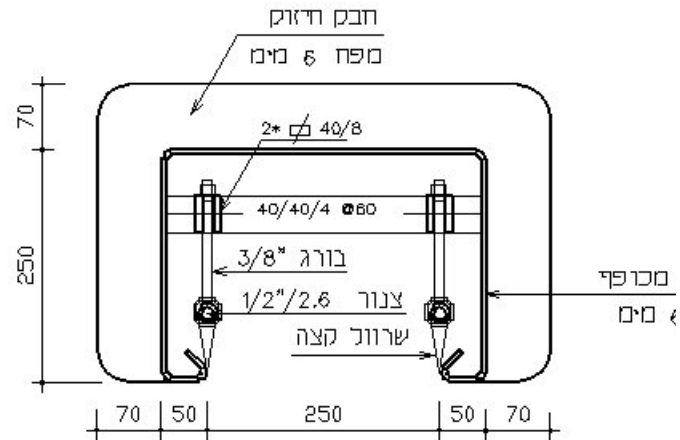

Cutting Pattern

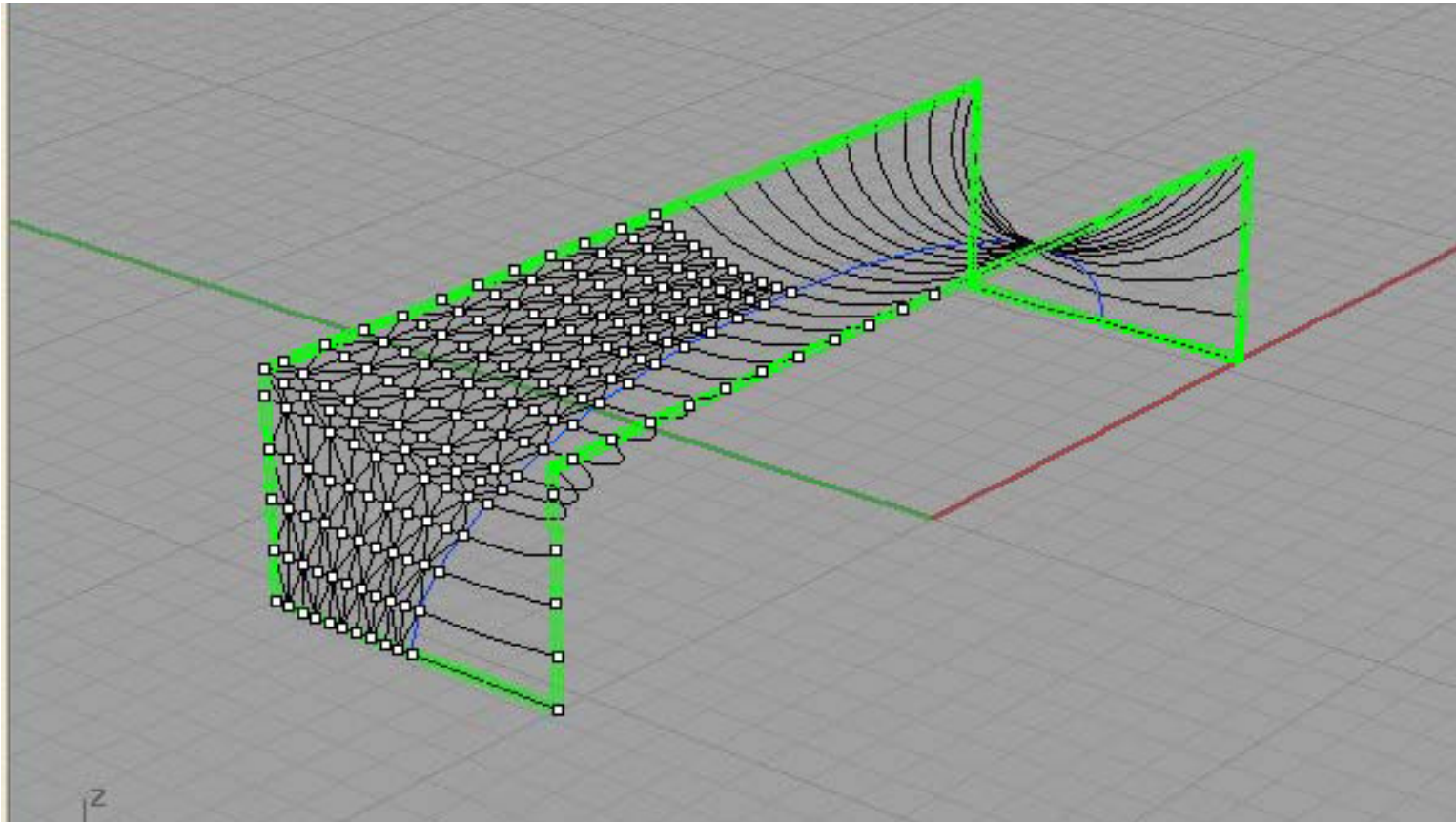

Cutting Pattern

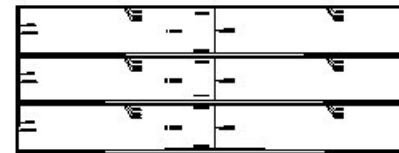
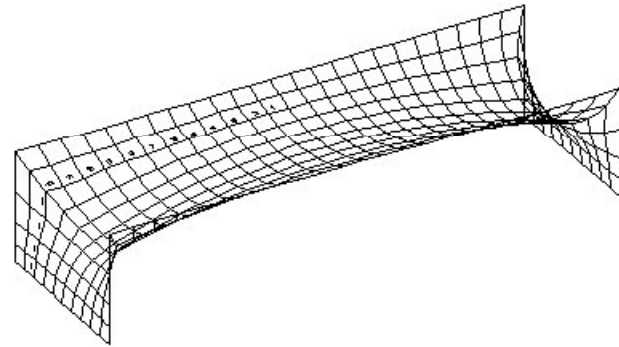

Application



Application



Application



Application



Application



Application



Application



Amado Membrane Structure



Amado Membrane Structure



Amado Membrane Structure



Amado Membrane Structure



Amado Membrane Structure



Amado Membrane Structure



Amado Membrane Structure

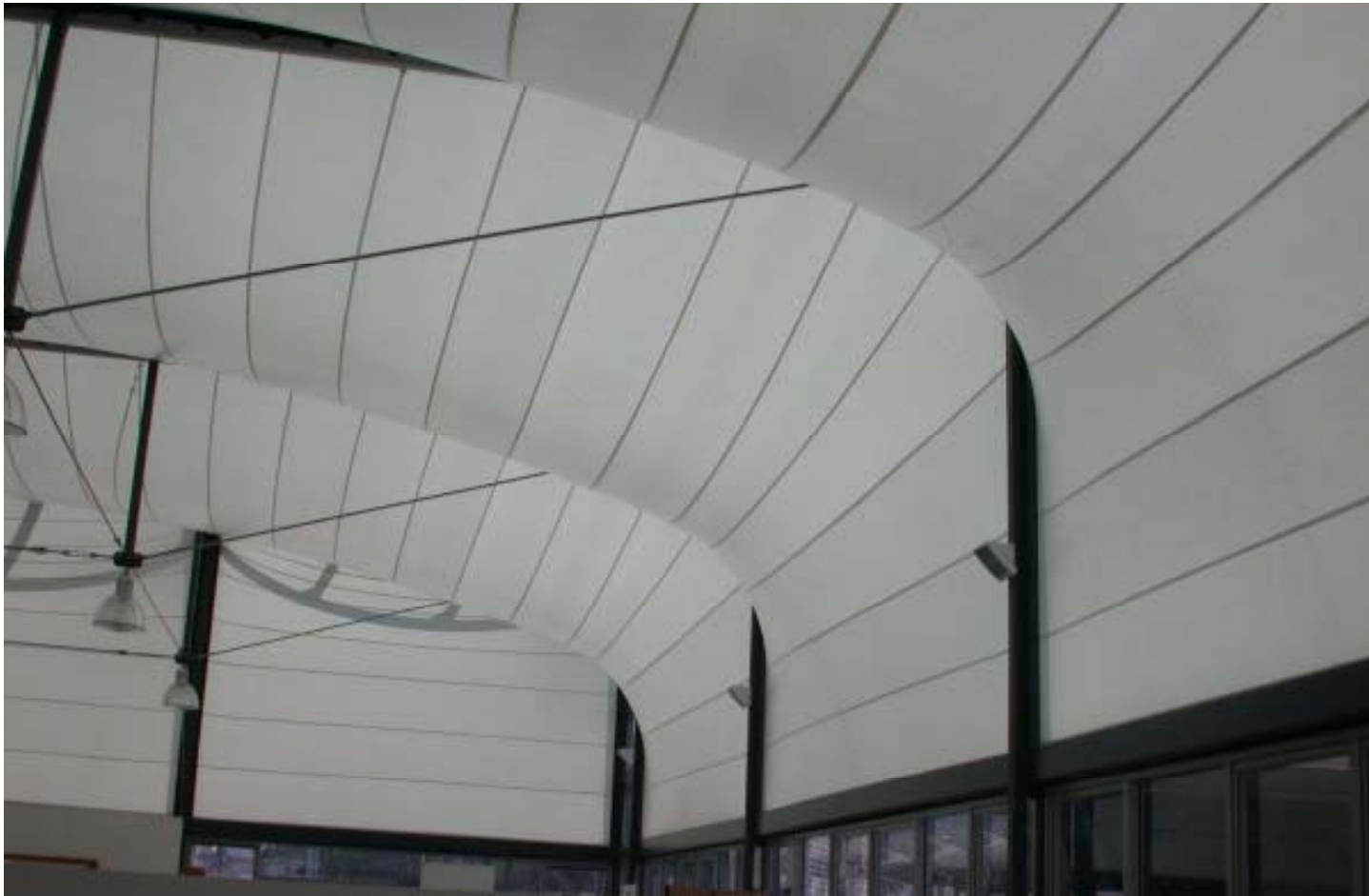

Amado Membrane Structure



Amado Membrane Structure



Amado Membrane Structure



Amado Membrane Structure



Amado Membrane Structure



Amado Membrane Structure



Amado Membrane Structure



Amado Membrane Structure



Amado Membrane Structure



Amado Membrane Structure



Amado Membrane Structure



Thanks

Burt - Korren